

# MgP series



Designation : 1500 V CAT III magnetic adaptor.

Applications : to connect measuring devices to electrical board screw terminal blocks.

Electro-PJP introduces its magnetic adaptor series with 1500 V CAT III / 1000 V CAT IV safety for RCD, RCCB, GFCI and circuit-breakers : MgP series.



Magnetic tip.

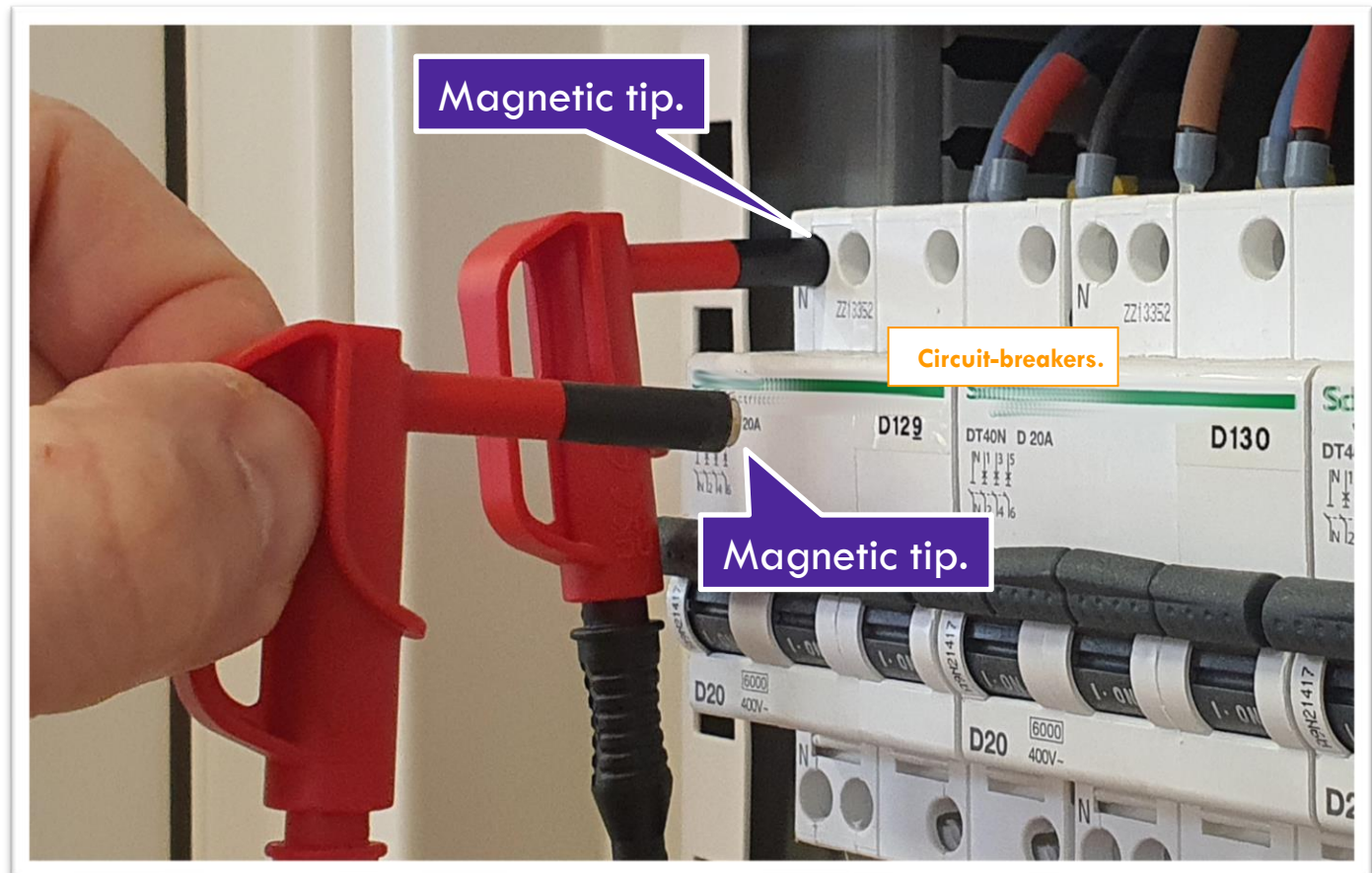

Magnetic tip.

Circuit-breakers.

Magnetic tip.

# MgP series



## DATA SHEET 2 of 6.

Designation : 1500 V CAT III magnetic adaptor.

Applications : to connect measuring devices to electrical board screw terminal blocks.

The magnetic adaptors of the MgP series “stick” to the steel screw heads of the RCD, RCCB, GFCI and circuit-breaker terminals. Their other end is a 4 mm banana female terminal designed to connect to measuring devices.



Thanks to their low profile and right-angled shape, the MgP series magnetic adaptors comply with the shapes and dimensions of the RCD, RCCB, GFCI and circuit-breakers. Their magnetic heads insert into the terminal hollows of the RCD, RCCB, GFCI and circuit-breakers, “stick” to their steel screw heads and make electrical contact.



The safety of the MgP series magnetic adaptors responds to the three-phase electrical board dangers and 1500 V DC photovoltaic infrastructure dangers. MgP series allows electrotechnicians to connect RCD, RCCB, GFCI and circuit-breakers to insulation meters, power quality analyzers, multimeters, oscilloscopes, special control benches, etc. to perform maintenance on industrial electrical cabinets, troubleshooting on industrial equipment, monitoring and analyzing of voltages and harmonics on electrical installations, verification of industrial machines after manufacturing, insulation measurements, measurements in direct current on 1500 V photovoltaic circuits, etc.



# MgP series



## DATA SHEET 3 of 6.

Designation : 1500 V CAT III magnetic adaptor.

Applications : to connect measuring devices to electrical board screw terminal blocks.





~Ø6,0 mm magnetic head.



~Ø6,6 mm magnetic head.



~Ø8,0 mm magnetic head.

Designation.	1500 V CAT III magnetic adaptor.		
Full designation.	Adaptor made of a round magnetic head to “stick” to the steel screw heads of RCD, RCCB, GFCI and circuit-breaker terminals on one side, and a 4 mm banana female terminal to connect to 4 mm banana male connectors on the other side.		
Connection durability (temporary or semi-temporary or durable).	Semi-temporary connection. A few hours. The adaptors are designed for a few hours continuous connections typically.		
Applications.	Connects measuring devices to RCD, RCCB, GFCI and circuit-breakers whose terminals are made of about 6,1 mm inner diameter hollows and steel screws.	Connects measuring devices to RCD, RCCB, GFCI and circuit-breakers whose terminals are made of about 6,7 mm inner diameter hollows and steel screws.	Connects measuring devices to RCD, RCCB, GFCI and circuit-breakers whose terminals are made of about 8,1 mm inner diameter hollows and steel screws.
Safety.	1500 V CAT II / 1500 V CAT III / 1000 V CAT IV, reinforced insulation. 4 amperes at 40 °C ambient temperature. Alternating current and direct current. According to EN / IEC 61010-031.		
Markings.	CATIII 1500V CATIV 1000V 4A  		
Colors.			
Packaging.	Bag of 10 adaptors of the same color (default packaging).		
Part number.	MgP6_0-IEC- Color	MgP6_6-IEC- Color	MgP8_0-IEC- Color



# MgP series



## DATA SHEET 4 of 6.

Designation : 1500 V CAT III magnetic adaptor.

Applications : to connect measuring devices to electrical board screw terminal blocks.





~Ø9,0 mm magnetic head.



~Ø10,0 mm magnetic head.



~Ø11,0 mm magnetic head.

Designation.	1500 V CAT III magnetic adaptor.		
Full designation.	Adaptor made of a round magnetic head to “stick” to the steel screw heads of RCD, RCCB, GFCI and circuit-breaker terminals on one side, and a 4 mm banana female terminal to connect to 4 mm banana male connectors on the other side.		
Connection durability (temporary or semi-temporary or durable).	Semi-temporary connection. A few hours. The adaptors are designed for a few hours continuous connections typically.		
Applications.	Connects measuring devices to RCD, RCCB, GFCI and circuit-breakers whose terminals are made of about 9,1 mm inner diameter hollows and steel screws.	Connects measuring devices to RCD, RCCB, GFCI and circuit-breakers whose terminals are made of about 10,1 mm inner diameter hollows and steel screws.	Connects measuring devices to RCD, RCCB, GFCI and circuit-breakers whose terminals are made of about 11,1 mm inner diameter hollows and steel screws.
Safety.	1500 V CAT II / 1500 V CAT III / 1000 V CAT IV, reinforced insulation. 4 amperes at 40 °C ambient temperature. Alternating current and direct current. According to EN / IEC 61010-031.		
Markings.	CATIII 1500V CATIV 1000V 4A  		
Colors.			
Packaging.	Bag of 10 adaptors of the same color (default packaging).		
Part number.	MgP9_0-IEC- Color	MgP10_0-IEC- Color	MgP11_0-IEC- Color

# MgP series



Designation : 1500 V CAT III magnetic adaptor.

Applications : to connect measuring devices to electrical board screw terminal blocks.

✗ 606Mg series is discontinued and replaced with MgP series.

... is ✗ discontinued ...	... and ✓ replaced with ...	Results :
Part number 606Mg4-IEC- <i>Color</i>	Part number MgP4_0-CII- <i>Color</i>	The magnetic head diameters are the same. The safeties are the same.
Part number 606Mg6-IEC- <i>Color</i>	Part number MgP6_0-CII- <i>Color</i>	
Part number 606Mg7-IEC- <i>Color</i>	Part number MgP7_0-CII- <i>Color</i>	

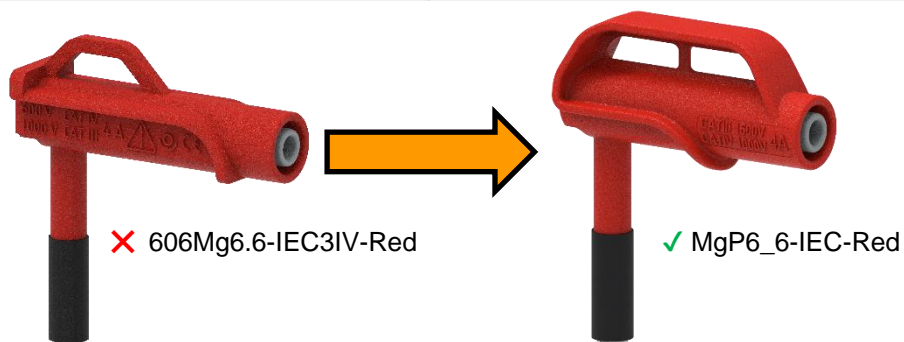

... is ✗ discontinued ...	... and ✓ replaced with ...	Results :
Part number 606Mg5_1x3_8-IECIV- <i>Color</i>	Not replaced.	The magnetic head diameters are the same. The safeties are higher.
Part number 606Mg6.0-IEC3IV- <i>Color</i>	Part number MgP6_0-IEC- <i>Color</i>	
Part number 606Mg6.6-IEC3IV- <i>Color</i>	Part number MgP6_6-IEC- <i>Color</i>	
Part number 606Mg8.0-IECIV- <i>Color</i>	Part number MgP8_0-IEC- <i>Color</i>	
Part number 606Mg9-IEC2- <i>Color</i>	Part number MgP9_0-IEC- <i>Color</i>	
Part number 606Mg10-IEC2- <i>Color</i>	Part number MgP10_0-IEC- <i>Color</i>	
Part number 606Mg11-IEC2- <i>Color</i>	Part number MgP11_0-IEC- <i>Color</i>	

# MgP series



## DATA SHEET 6 of 6.

Designation : 1500 V CAT III magnetic adaptor.

Applications : to connect measuring devices to electrical board screw terminal blocks.

Feel free to contact us at :

[sales@electro-pjp.com](mailto:sales@electro-pjp.com)

+33 (0) 384 821 330

[www.electro-pjp.com](http://www.electro-pjp.com)

ELECTRO-PJP  
ZI Charmes d'Amont  
13 rue de Madrid  
39500 TAVAUX  
FRANCE



- Conformity
- CE marking. UKCA marking.
  - European Directive "Low Voltage Directive" 2014/35/UE.
  - International / European standard EN / IEC 61010-031.
  - European Directive "RoHS" 2011/65/EU. European Directive 2015/863/EU.
  - European regulation n°1907 / 2006 "REACH".
  - European regulation 2017 / 821 "Conflict minerals".
  - British statutory requirements 2016 No. 1101. The Electrical Equipment (Safety) Regulations.
  - American "TSCA" Toxic Substances Control Act.

- Origin
- Made and designed in France.

CONFIDENTIEL. A L'INTENTION EXCLUSIVE DES DESTINATAIRES. NE PAS REPRODUIRE NI DIFFUSER SANS L'AUTORISATION PREALABLE D'ELECTRO-PJP.  
 CONFIDENTIAL. INTENDED SOLELY FOR THE RECIPIENTS. DO NOT REPRODUCE OR CIRCULATE WITHOUT THE ELECTRO-PJP'S PRIOR AUTHORISATION.

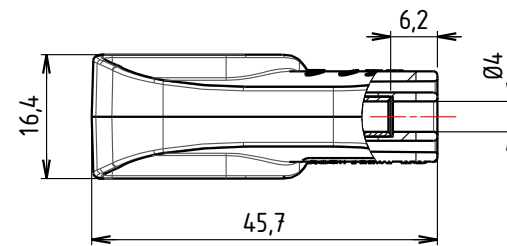
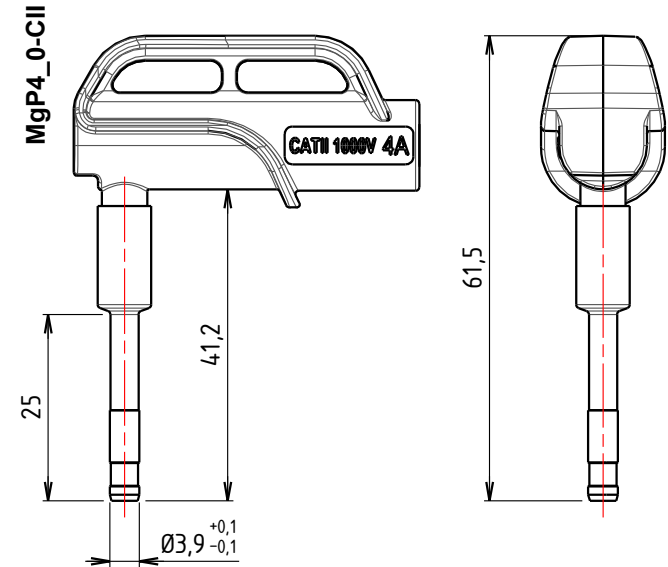
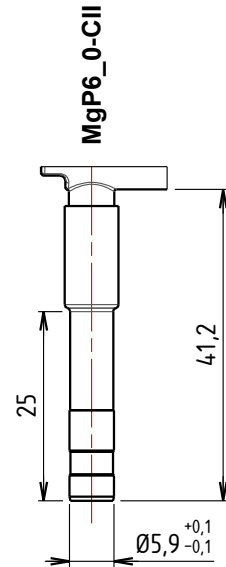
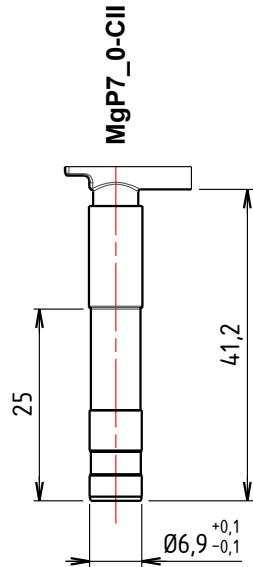

**Electrical Safety** according to

- European Directive "Low Voltage Directive" 2014/35/UE,
  - and International / European standard EN / IEC 61010-031.
- Operating voltage / measuring category : 1000V CAT II  
 Pollution degree : 2  
 Max. current : 4A



**Ambient Conditions**

Operating temperature range : 0°C ... +40°C  
 Max. relative humidity : 80% up to 31°C with linear reduction down to 50% relative humidity at 40°C.  
 Altitude : 2000m  
 Place of use : Indoors, except within specified ambient conditions.

**Environment**

- European Directive "RoHS" 2011/65/EU. European Directive 2015/863/EU.
- European regulation n°1907 / 2006 "REACH".
- European regulation 2017 / 821 "Conflict minerals".

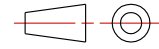
-	-	-	-
-	-	-	-
-	-	-	-
-	-	-	-
A	First draft	PG.B	22-06-2023
Revision	Modifications	DFTMN	Date

#	R	N	Bl	V	J	Bc	Vt	O	Bn	G
Available colours <i>Others on request</i>	X	X	X	X		X			X	X
Scale: 1:1	 <b>MAGNETIC ADAPTOR</b> <b>ADAPTATEUR MAGNETIC</b>					Author: PGB	<b>A4</b> Revision A Folio n/p			
						Units: Metric				
						P/N: See above				
						ELECTRO-PJP ZI Les Charmes d'Amont - Rue de Madrid 39500 TAVAUX FRANCE PHONE : +33 (0)384 821 330 FAX : +33 (0)384 824 048				
						The reproduction of this document even partial is strictly prohibited. 				
						Project name : 60619 - MGP Project part number :				

CONFIDENTIEL. A L'INTENTION EXCLUSIVE DES DESTINATAIRES. NE PAS REPRODUIRE NI DIFFUSER SANS L'AUTORISATION PREALABLE D'ELECTRO-PJP.  
 CONFIDENTIAL. INTENDED SOLELY FOR THE RECIPIENTS. DO NOT REPRODUCE OR CIRCULATE WITHOUT THE ELECTRO-PJP'S PRIOR AUTHORISATION.

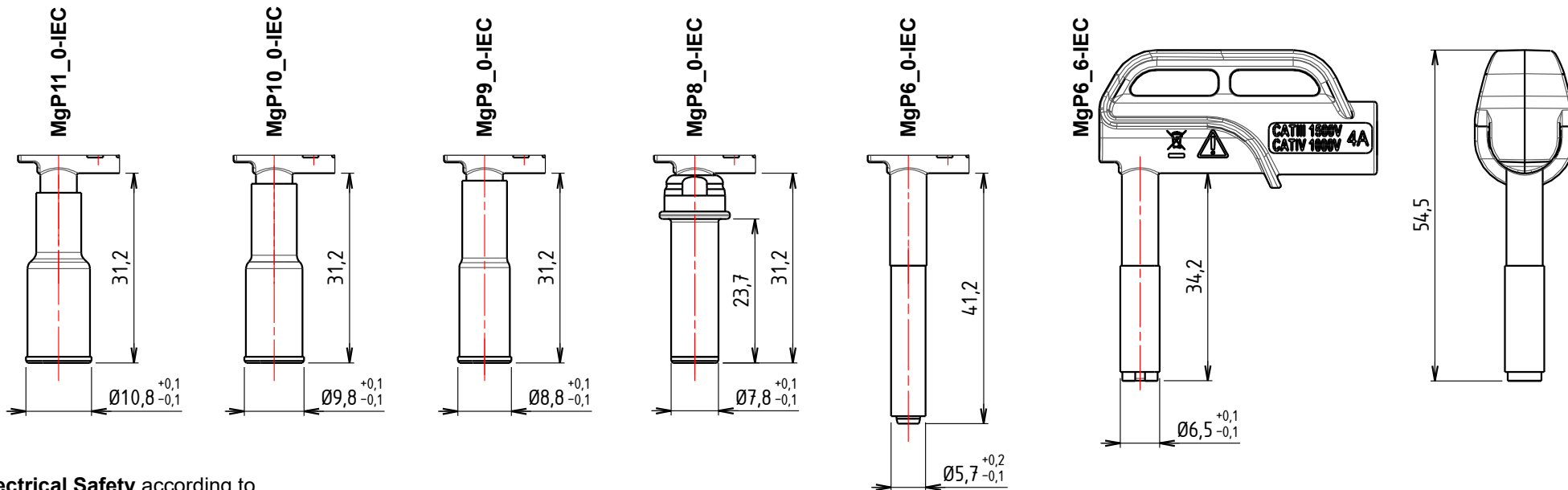

**Electrical Safety** according to

- European Directive "Low Voltage Directive" 2014/35/UE,
  - and International / European standard EN / IEC 61010-031.
- Operating voltage / measuring category : 1500V CAT III / 1000V CAT IV  
 Pollution degree : 2  
 Max. current : 4A

**Ambient Conditions**



Operating temperature range : 0°C ... +40°C  
 Max. relative humidity : 80% up to 31°C with linear reduction down to 50% relative humidity at 40°C.  
 Altitude : 2000m  
 Place of use : Indoors, except within specified ambient conditions.

**Environment**

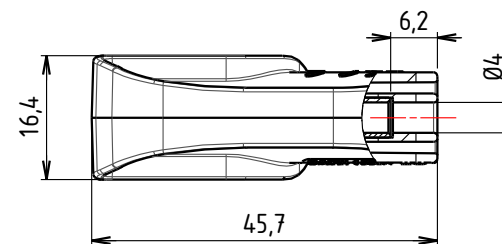
- European Directive "RoHS" 2011/65/EU. European Directive 2015/863/EU.
- European regulation n°1907 / 2006 "REACH".
- European regulation 2017 / 821 "Conflict minerals".

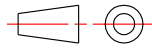

-	-	-	-
-	-	-	-
-	-	-	-
B	Part number MgP5_1x3_8 is removed	PG.B	13-09-2023
A	First draft	PG.B	22-06-2023
Revision	Modifications	DFTMN	Date

#	R	N	Bl	V	J	Bc	Vt	O	Bn	G
Available colours <i>Others on request</i>	X	X	X	X		X			X	X
Scale: 1:1						MAGNETIC ADAPTOR		Author: PGB		A4
						ADAPTEUR MAGNETIC		Units: Metric		
						P/N: See above		Revision B		Folio n/p
						ELECTRO-PJP ZI Les Charmes d'Amont - Rue de Madrid 39500 TAVAUX FRANCE PHONE : +33 (0)384 821 330 FAX : +33 (0)384 824 048 The reproduction of this document even partial is strictly prohibited. 